

# PROTOTYPE CRYOMODULE FOR THE ADS LINAC

S. Noguchi<sup>†</sup>, E. Kako, Nori. Ohuchi, K. Saito, T. Shishido and K. Tsuchiya  
KEK, High Energy Accelerator Research Organization  
1-1 Oho, Tsukuba, Ibaraki, 305-0801, Japan  
Nobu. Ouchi  
JAERI, Japan Atomic Energy Research Institute  
Tokai-mura, Naka-gun, Ibaraki, 319-1195, Japan

## Abstract

For the future application of the superconducting LINAC to the accelerator driven system (ADS), a prototype cryomodule is being constructed under the collaboration of Japan Atomic Energy Research Institute (JAERI) and High Energy Accelerator Research Organization (KEK). The module contains two 9-cell structures of  $\beta=0.725$  and  $f=972\text{MHz}$ . The design of the cryomodule and the status of the construction are reported.

## INTRODUCTION

As the first step of the long-term R&D program of the ADS project, an ADS experimental facility and a 200MeV superconducting linac will be constructed in the second phase of the J-PARC project. The purposes of this program are to study and resolve technology issues of the system, and to demonstrate the feasibility of the ADS concept. The baseline design of the superconducting linac in the energy range of 400-600MeV was reported in the last SRF workshop [1]. In the late 2002, the construction of a prototype cryomodule was approved as a three years program.

## CRYOMODULE

The cryomodule is similar to the TRISTAN cryomodule as is shown in Figure 1. The main changes adopted are

- 1: Jacket type He vessel of Titanium
- 2: 2K operation
- 3: Pulsed operation

In order to cope with these changes, some new techniques, such as SUS/Ti joint, seals for 2K-He are used, so the system have to be examined experimentally. The main purpose of the cryomodule is to examine the cryogenic performance at 2K and the controllability of the accelerating gradient in the pulsed operation.

2K-He is provided from a He Dewar through a heat exchanger in a valve box and a J-T valve in the cryostat. Maximum design heat load at 2K is 7W for dynamic and 8W for static. Consumption of 4.4K-He is estimated to be 46 liter/hour for 2K-He production, and 35 liter/hour for 5K shield. Volume of a 2K-He reservoir is 17 liters. Figure 2 shows the vacuum vessel.

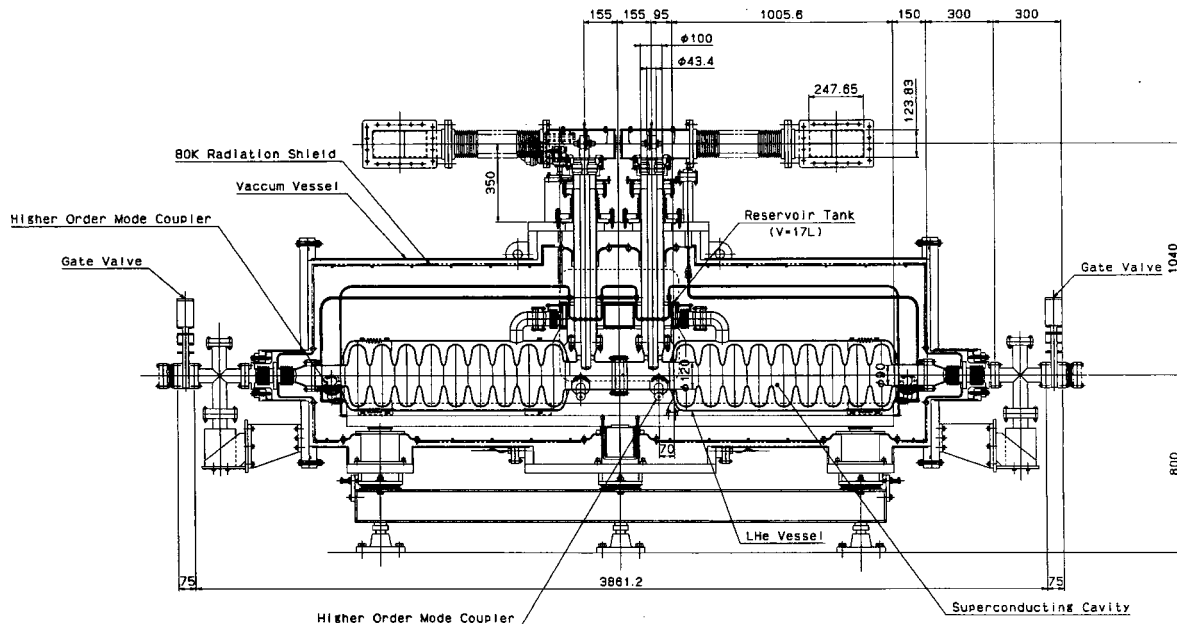

Figure 1: A 972MHz prototype cryomodule.

<sup>†</sup>shuichi.noguchi@kek.jp

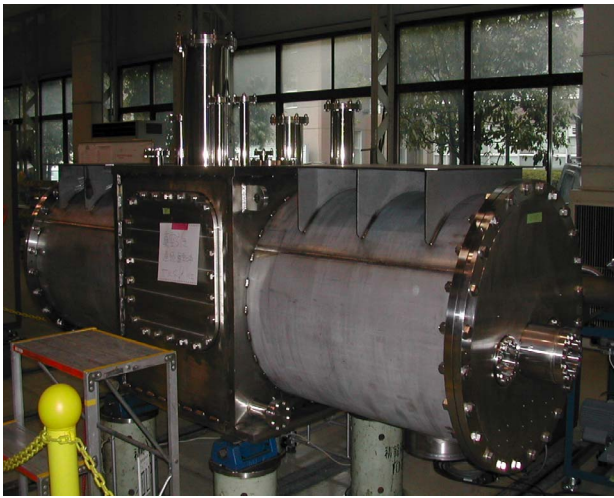

Figure 2: Vacuum vessel.



Figure 3: A welded center-cells.



Figure 4: An end-cell with a titanium endplate.

## CAVITY

The cavities [2] are made of standard Tokyo Denkai Nb (RRR~250) of 4mm thick. The simulation of dynamic Lorentz detuning in a pulsed operation shows that errors in the accelerating gradient can be suppressed at the level less than  $1^\circ$  and 1% at the Eacc of 10 MV/m, if the stiffness of a tuning system is larger than 50kN/mm. Figure 3 shows a welded center-cells, and Figure 4 is an end-cell with a titanium endplate of a He vessel. Two cavities have been already completed, tuned and tested. Figure 5 shows a cavity under pre-tuning, [3]. The first test results were not good (Eacc,max = 7 MV/m), and a light electropolishing will be tried again.

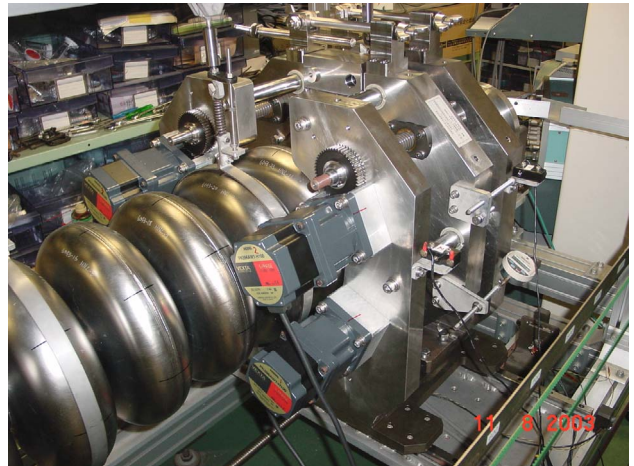

Figure 5: Pre-tuning system.

## COUPLERS

Input couplers are scaled from the TRISTAN coupler. Figure 6 shows two couplers and waveguide transformers on a table. Four couplers have been already made and tested [4]. One pair of couplers cleared the design specification (350kW, 3msec and 25Hz) and was tested safely up to 2.2MW in the pulse condition of 0.6msec and 25Hz. The other pair was tested up to 1.1MW, but has not been tested in 3msec mode because of limitation of a klystron power supply.

DESY type HOM couplers are being made. They have a two-post high pass filter and a  $\lambda/4$  notch filter as shown in Figure 7. Figure 8 is a transfer property calculated by HFSS. Two HOM couplers are equipped, one for each beam pipe. Estimated external Q values for the accelerating mode are  $1 \times 10^6$  for a coupler on a larger beam pipe of D=126mm and  $1 \times 10^7$  for another on a smaller beam pipe of D=90mm. The bandwidth at 50dB rejection is about 50MHz. The calculation shows that the loss of the weaker coupler is 2W even if it is made of Cu and used under CW operation at 10MV/m. So, we decided to make them by Cu and examine the performance.



Figure 6: Input couplers.

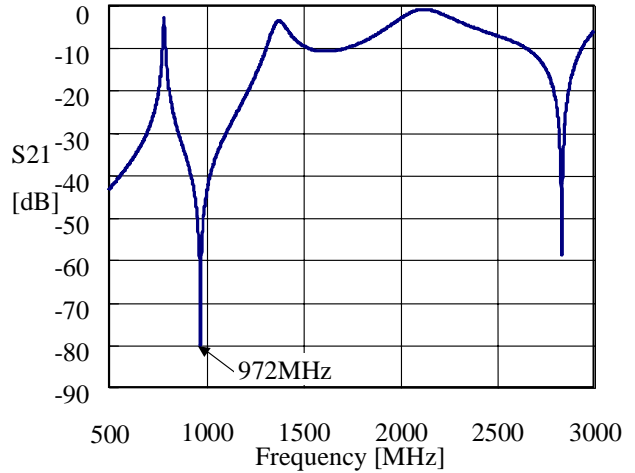

Figure 8: Transfer property (S21).

### TUNER

In order to suppress the dynamic Lorentz detuning, not only the cavity but also the tuning system has to be stiff. The simulation shows that the stiffness of the tuning system must be larger than 50kN/mm to keep the errors of the accelerating gradient less than 1° and 1%. To satisfy this condition, a system is made by very thick (~2cm) Ti endplates and two coaxial power transmitters. The outer pipes of the coaxial transmitters are fixed on one of two Ti flanges welded to a Ti bellow. The inner rods hook and pull the other Ti flange. Coaxial transmitters are driven by a stepping motor and a piezo-transducer outside the cryostat. Since thermal conduction is proportional to stiffness, thermal anchors become necessary as is shown in Figure 9. Figure 10 shows the tuning system under testing with dummy springs.

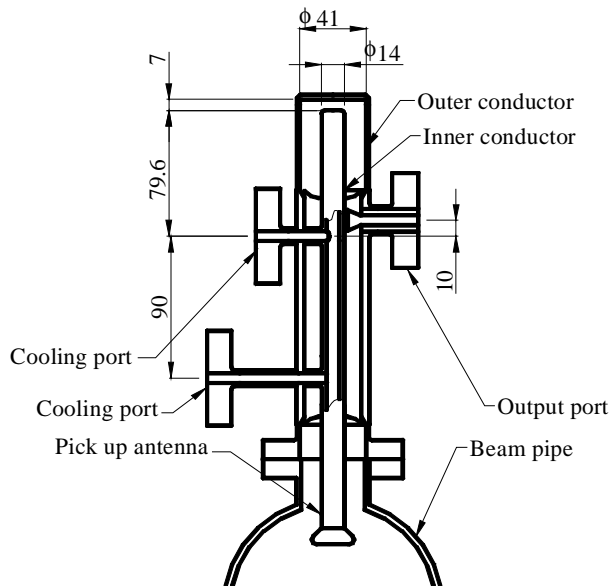

Figure 7: HOM coupler.

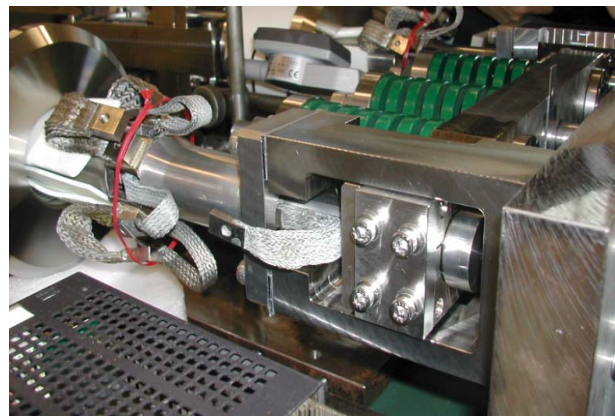

Figure 9: A coaxial transmitter attached on a dummy stainless plate.



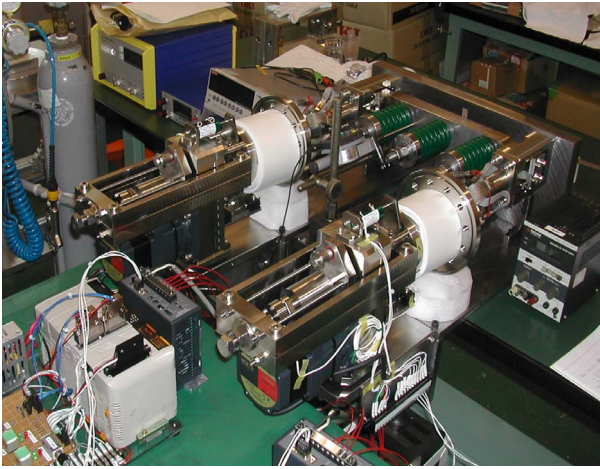

Figure 10: A set of coaxial power transmitters under testing.

## SUMMARY

The prototype cryomodule has been nearly completed. After confirming the design gradient of 10 MV/m, the cavities will be joined with Ti jackets. The assembling of the cryomodule will start at the JAERI experimental hall.

## ACKNOWLEDGEMENTS

This work was supported by Ministry of Education, Culture, Sports, Science and Technology.

The authors would like to thank staffs of Mitsubishi Heavy Industries for helpful supports to the design work.

## REFERENCES

- [1] S. Noguchi, "SRF System in the JAERI-KEK Joint Project", Proc. of 10<sup>th</sup> Workshop on RF Superconductivity, Tsukuba, Japan (2001) p302-307.
- [2] E. Kako and S. Noguchi, "RF Design of a 972MHz Superconducting Cavity for High intensity Proton Linac", Proc. of EPAC2002, Paris, France (2002) p2244-2246.
- [3] T. Shishido, E. Kako and S. Noguchi, "Development of Pre-tuning System for 972MHz 9-cell Superconducting Cavities", in this conference, (TuP42).
- [4] E. Kako, S. Noguchi and T. Shishido, "Input Couplers for 972MHz Superconducting Cavities in the High Intensity Proton Linac", in this conference, (ThP27).